

Manufacturer: **Hatteland Technology AS**
 Product: **13.3 inch Single Cable Monitor (SCM)**
 Type: **HD 13T30 SCM-Jxx-Vxxx**
 where x = configuration

Last Revised: **20 Feb 2023**
 Revision#: **03**

13.3 inch Single Cable Monitor - Series E

Features:

The Series E - HATTELAND® Single Cable Monitor (SCM) delivers a reliable all-in-one solution for diverse maritime applications and enables tangible cost savings for maritime technology and equipment manufacturers as well as systems integrators.

The integrated nature of Series E Single Cable Monitors enables tangible cost savings for maritime technology and equipment manufacturers as well as systems integrators. The portfolio features a range of display sizes, new USB-C interface technology which carrying DP, power and USB signals, Daisy chain capability, which enables single cable operation. Providing full flexibility to integrate the highest quality displays in a wider range of maritime technology. Especially suited to developing new bridge solutions, Series E Monitors make it possible to continue improving safety and efficiency through safe navigation, while still retaining focus on quality and cost.

Series E Single Cable Monitors also meet the same extreme quality standards as the proven Series X Monitor range and feature LED Backlight Technology, full dimming (0-100%) all as standard. In addition there are features such as USB-C PD Sink and optional DC input.



FRONT VIEW

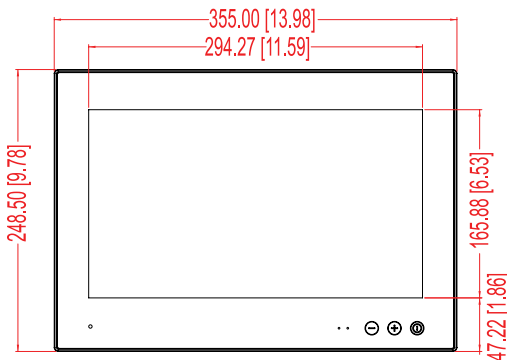

SIDE VIEW

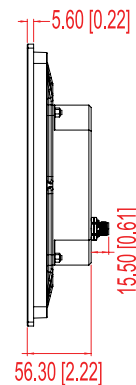

BACK VIEW

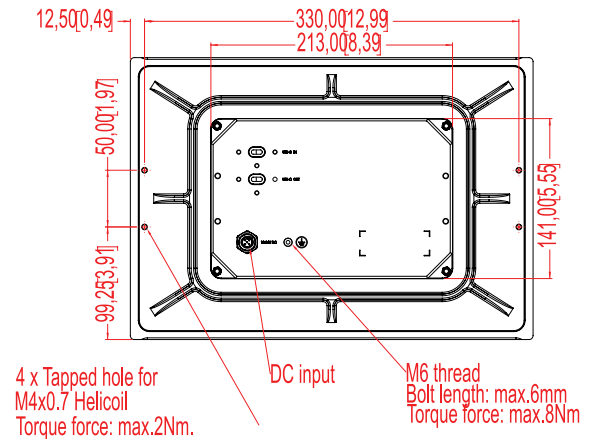

BOTTOM VIEW

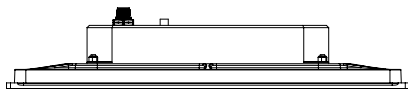

TOP VIEW

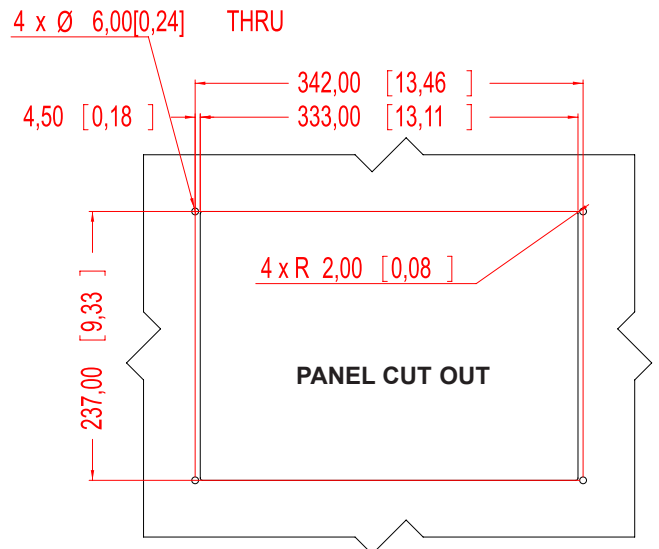
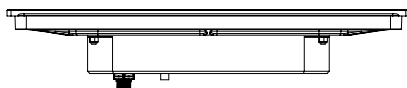

Dimensions might be shown with or without decimals and indicated as mm [inches]. Tolerance on drawings is +/- 1mm. For accurate measurements, check relevant DWG file.

TFT Technology:

- 13.3 inch TFT Liquid Crystal Display module, VA (Vertical Alignment)
- a-si TFT Active Matrix
- Widescreen, Aspect Ratio 16:9
- LED Backlight Technology

TFT Characteristics:

- Native Resolution : 1920 x 1080 (FHD)
- Pixel Pitch (RGB) : 0.1529(H) x 0.1529(V) mm
- Response Time : 25ms (tr+tf) (typ)
- Contrast Ratio : 600:1 (typ)
- Light Intensity : 600 cd/m² (typ)
- Viewable Angle : 85 deg. (up/down/left/right) (typical)
- Active Display Area : 293.76 (H) x 165.24 (V) mm
- Max Colors : 16.7 million (24-bit)

Pixel Defect Policy:

https://www.hattelandtechnology.com/hubfs/pdf/misc/ind100351-1_pixeldefectpolicy.pdf

Supported Signals:

Resolutions:

- VGA : 640 x 480 (including 640 x 350)
- SVGA : 800 x 600 (including 720 x 400)
- XGA : 1024 x 768
- SXGA : 1280 x 1024
- UXGA : 1600 x 1200
- FHD : 1920 x 1080 ^[2]

^[2] Recommended for optimal picture quality

^[2] [USB-C PD Supports DisplayPort signal - up to 1920 x 1080 \(FHD\)](#)

Power Specifications:

Power Supply Options:

- Single DC Power : 12-24VDC
- USB-C PD Sink ^[3] : 20VDC/3A (Requested)

Power Consumption:

- Operating : 16W (typ) - 24W (max)
- USB-C PD Sink ^[3] : 60W (Requested)

^[3] USB-C PD Sink will request 20V/3A (60W) from source.

Note: If already connected to USB-C (Supports PD sink) and additional external power is connected to the display, internal 12V PSU will start to deliver power through USB-C. User may experience short interval of black screen blinking.

Physical Dimensions:

Product Dimensions and Weight:

- W:355.00 [13.98"] x H:248.50 [9.78"] x D:71.80 [2.83"] mm [inch]
- Weight approx: 2.3kg / 5.1lbs

User Controls:

Behind front bezel - Glass Display Control™ (GDC) IP67:

- 3 x Buttons (Power On/Off, Brightness +/-), Status LED
- Buzzer (through glass), Light Sensor (behind glass)

Remote Control:

- DDC/CI over DP (over USB-C) ^[1]
- SCOM over DP (over USB-C) ^[1]

^[1] See latest revision of user manual

Environmental Considerations:

- Operating Temperature : -15°C to +55°C
- Storage Temperature : -20°C to +60°C
- Humidity : Humidity up to 95% (Operating / Storage)
- IP-Rating Protection : IP67 front - IP67 rear (EN60529)
- Air Pressure max Alt. : Operating: 3000m - Storage: 3000m
- Compass Safe Distance : Standard: **TBD**cm - Steering: **TBD**cm

Lifetime Considerations:

Even though the test conditions for bridge units provide for a maximum operating temperature of 55°C, continuous operation of all electronic components should, if possible, take place at ambient temperatures of only 25°C. This is a necessary prerequisite for long life and low service costs.

Input/Output Interfaces:

- USB-C Output : 1 x USB-C with DP+USB2.0 signals, IP67 Female
- USB-C Input : 1 x USB-C with DP+power (sink)+USB2.0, IP67 Female
- DC Input : 1 x 4-pin M12 Code A

Factory Defaults:

- Projected Capacitive Touch Screen (Multitouch,USB,Pen/Glove support)
- Optical Bonding Technology
- AG Coated Front Glass, no sharp edges
- PCTS MultiTouch Screen, USB, Water Rejection, Salt Spray<=3.5% salinity
- 1 x P014441 (IP66 Mount Gasket (EPDM))
- 1 x HD CMB SX2-C1 (Console Mount Kit. EN60945 Tested)
- NY-WP199, Protective CAP for M12 connector
- P031003#02, USB-C IPXX Protective CAP 2 (rubber)

Factory Options:

- T21 Front
- Customized Front

Available Accessories:

- HD CMB SX2-C1 : 1 x Console Mount Kit. EN60945 Tested
- HD TMB SX2-A3 : 1 x Table/Ceiling Mount Bracket. Not EN60945 Tested
- HD VED SX2-L1 : 1 x VESA Adapter (75/75,100/100). Not EN60945 Tested)
- VSD 203462-1 : 1 x Type C USB3.1 External cable - Male to Male IP67, 2m
- HD 13COV STD-A1 : 1 x UV Sun Cover
- HT DPUSB-2-USBC-A1 : 1 x DP & USB2.0 (Female) to USB-C (Male) Adapter, 2m (not IP67)
- HT HDMIUSB-2-USBC-A1 : 1 x HDMI & USB2.0 (Female) to USB-C (Male) Adapter, 2m (not IP67)

Please see user manual/datasheet/drawings for more information

Available Models:

- **HD 13T30 SCM-IA1-VOGG**
13.3" SCM Bonded USBC-PDSink Black IP67 GDC Buzzer PCTouch/AG
- **HD 13T30 SCM-JA1-VOGG**
13.3" SCM Bonded USBC-PDSink + DC Black IP67 GDC Buzzer PCTouch/AG

APPROVALS & CERTIFICATES

This product have been tested / type approved by the following classification societies: (*=pending)

IEC 60945 4th (EN 60945:2002)*

IACS E10*

EU RO MR - Mutual Recognition by DNV*

KR - Korean Register of Shipping*







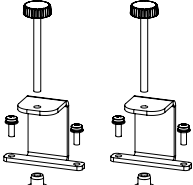
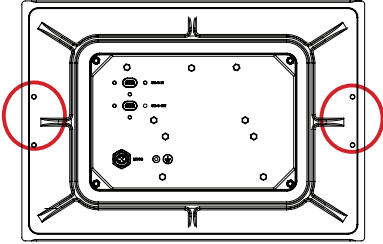
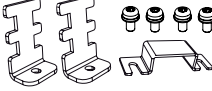

ABS - American Bureau of Shipping*

BV - Bureau Veritas*

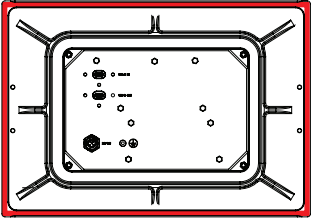
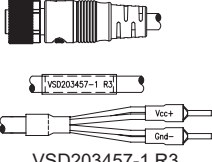
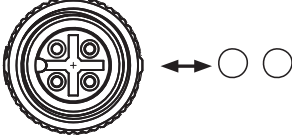
CCS - China Classification Society*

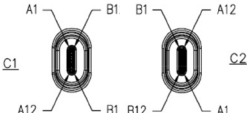
ClassNK - Nippon Kaiji Kyokai*

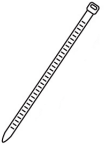
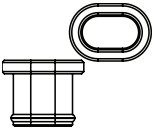
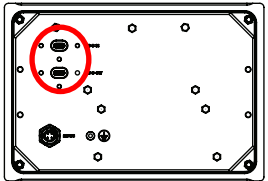
Details: Contents of Package

Item	Description	Illustration
 <p>HD CMB SX2-C1 Console Mounting Bracket Kit 13 inch models</p>	1 x Console Mounting Bracket Kit	
 <p>DP/HDMI/USB-C Reinforcement bracket</p>	1 x DP/HDMI/USB-C Reinforcement bracket	
	1 x IP66 Mount Gasket (EPDM), Flush/Console mount Details / Type number reference: Surface: RAL9011, Glue: ATP S-4215 MF, Thickness 2mm.	
 <p>VSD203457-1 R3</p>	1 x M12AF04A-WT-5M-02 External Power cable 5 meters	
	1 x USB-C external cable for 4K@24b@60Hz. IP67. Length 2.0m	
 <p>NY-WP199</p>	1 x Dust Cover cap for M12 connector Factory Pre-mounted	
 <p>B2-100 black cable tie 2,5x100mm</p>	2 x Cable Tie 2,5x100mm CT-100-2KB BLACK	
 <p>P031003</p>	2 x Dust Cover cap for USB-C (rubber) Factory Pre-mounted	
	Test Report Papers	

Details: Product Labels

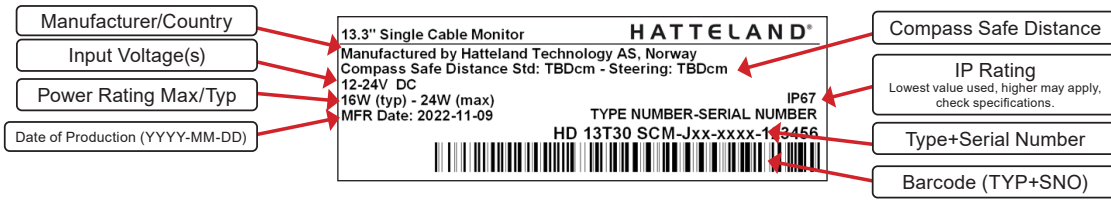

Please note that typenumber shown above is a generic sample only. May not reflect products mentioned in this manual. Please review actual product S/N label.

ID	Label Layout	Description	Specification
1		<p>Type : Serial Number Label Size : 60mm wide x 20mm high (rectangle size)</p> <p>Label 1 of 2 mounted as illustrated below. Label 2 of 2 mounted on Main Box in "LABEL" area.</p> <p>Barcode type: CODE128 (used extensively world wide in shipping and packaging industries. The symbology was formerly defined as ISO/IEC 15417:2007.)</p>	Silver with glue on back, non-tearable and made for thermal transfer printing.
9		<p>Type : IND105459-5 (Product Label) Size : 60mm wide x 26mm high (rectangle size)</p> <p>Description: Label compliance to IACS E10, product safety (EN 62368) and Commissioning Regulation (EU) 2019/2021.</p>	Black Lexan 0.125 with 3M467 Adhesive
4		<p>Type : Warranty Label Size : 30mm wide x 23mm high (oval size)</p>	Tamper-proof sticker with glue on back.

Details: Label Positions

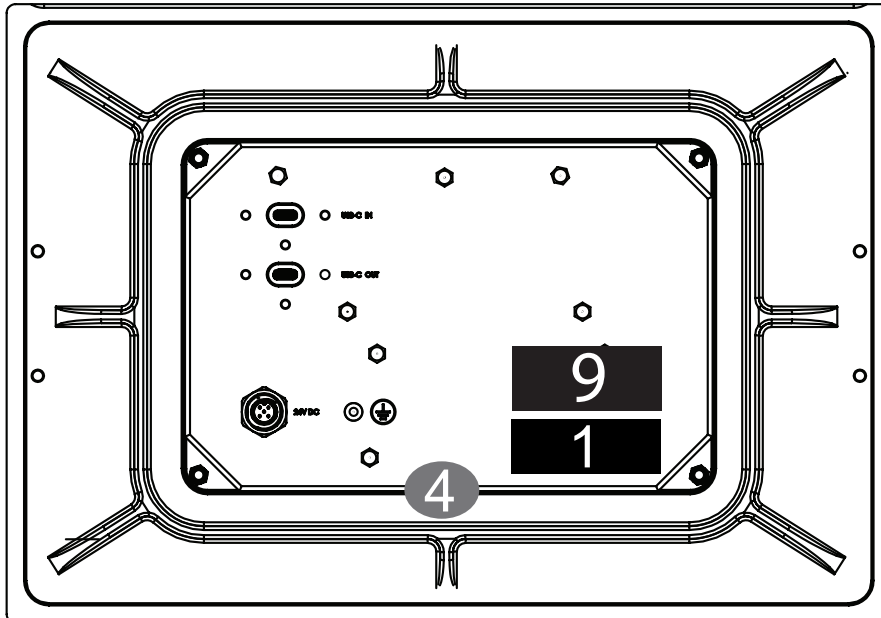

Details: Supported SCOM commands

CMD

Message Commands and Queries (CMD) Contents

The command can be one of the following values and consists always of 3 bytes in positions 2,3,4:

Byte 2	Byte 3	Byte 4	ASCII	Description	I/O	Non-Volatile / Volatile	Page
0x42	0x52	0x49	BRI	Minimum Brightness	R/W	NV	15
0x42	0x52	0x4D	BRM	Maximum Brightness	R/W	NV	16
0x42	0x52	0x54	BRT	Brightness Control	R/W	V	17
0x42	0x52	0x4C	BRL	GDC LED Brightness Control	R/W	NV	18
0x42	0x52	0x55	BRU	User Brightness Control	R/W	NV	19
0x47	0x4D	0x42	GMB	GDC minimum brightness	R/W	NV	20
0x47	0x42	0x46	GBF	Keypad Brightness auto follow	R/W	NV	21
0x4C	0x49	0x53	LIS	Read Ambient Light Sensor	R		24
0x4F	0x44	0x4D	ODM	Outdoor Mode	R/W	NV	25
0x52	0x45	0x43	REC	Recall GDC	W		26
0x50	0x4F	0x54	POT	Potential Meter Control	R/W	NV	27
0x42	0x5A	0x5A	BZZ	Buzzer Control On/OFF	R/W	V	28
0x53	0x57	0x49	SWI	Read NXP Firmware Version	R		30
0x53	0x57	0x56	SWV	Read Video Scaler Firmware Version	R		30
0x54	0x59	0x50	TYP	Read Type Number	R		31
0x53	0x4E	0x42	SNB	Read Serial Number	R		31
0x53	0x43	0x49	SCI	Write Customer Service ID	W	NV	32
0x43	0x53	0x49	CSI	Read Customer Service ID	R		32
0x45	0x54	0x43	ETC	Elapsed Time Counter Query System	R		32
0x4D	0x41	0x4E	MAN	Read Manufacture ID Code	R		33
0x54	0x4D	0x50	TMP	Read Temperature Sensor	R		33
0x56	0x45	0x52	VER	Inquiry specific Type Number	R		34
0x46	0x57	0x56	FWV	Inquiry Firmware Versions	R		34
0x43	0x42	0x52	CBR	COM1&2 Port Baudrate	R/W	NV	35
0x42	0x41	0x4B	BAK	Turn on/off acknowledge on broadcast command	R/W	NV	36
0x44	0x4C	0x4E	DLN	Download ECDIS Package	R		37
0x44	0x4C	0x3F	DL?	Request Number of available ECDIS Pack	R		38
0x43	0x41	0x4C	CAL	ECDIS calibrated brightness inquiry	R		39
0x52	0x43	0x46	RCF	Recall Factory default	W		40
0x50	0x57	0x52	PWR	Power On/Off/Sleep unit	W		41
0x56	0x55	0x52	VUR	Read User Configuration from Video Scaler	R		42
0x56	0x55	0x53	VUS	Write User Configuration to Video Scaler	W		43
0x07	0xFF	0x4D	MOD	Operation Mode Selection	R/W		44
0x4D	0x43	0x43	MCC	OSD Menu Control Commands + Commands List Table*	R/W		45-54

I/O = R=Read, W=Write.

Volatile = V=The variable values controlled by these commands are cleared at power restart).

Non-Volatile = NV=The variable values controlled by these commands are stored even after power restart.

Page # = Page number in this manual where command is detailed.

*MCC

OSD Menu Control Commands. "MCC" command also features a Query "?" mode, "R" or "r" reset mode to factory default, increase +1 from current value "+" and decrease -1 from current value "-". Details and usage of these commands are available later in this manual.

Details: Supported DDC/CI commands

Introduction

DDC/CI (Display Data Channel/Command Interface) specifies a means for a computer to send commands to the unit's Display Video Controller to programmatically adjust parameters of the display instead of pressing physical buttons or navigate through an OSD menu. Specific commands to control units are defined in a separate official Monitor Control Command Set (MCCS) industry standard. The signal inputs supported are DVI*, HDMI, DisplayPort (DP) and VGA*.

To determine if your unit has the DDC/CI commands supported as described in this chapter, please review the "On Screen Display (OSD) Menu" chapter (Service section) in this manual.

It is expected that the user has previous experience of the DDC/CI protocol and how to implement the commands in their own control applications. A suitable starting point for sending commands, are the GUI operated (or command line version) of softMCCS software, reference: <http://www.entechtaiwan.com/lib/softmccs.shtm>

The listed DDC/CI commands below are equivalent to the same functions available in the well implemented Hatteland Technology Serial/Ethernet Communication Control Interface (SCOM) protocol, where specified, reference: <https://www.hattelandtechnology.com/hubfs/pdfget/inb100018-6.htm>

The column "SCOM" is a reference and not part of the DDC/CI commands explained in the table below.

*NOTE: This chapter is an overall description of DDC/CI support for various/selected Hatteland Technology products. References to VGA (RGB), DVI and Composite may not be present on your product, due to hardware changes/Engineering Change Notifications issued for Multi Vision Displays (MVD), please check actual datasheet for your model to verify.
Reference: <https://www.hattelandtechnology.com/product-notifications/hardware-change-/upgrade-for-32inch-and-55inch-products>

Syntax: [S] = Start Condition & [P] = Stop Condition (marked with gray color). Numbers in black/green/red colors are Byte Value in Hexadecimal.

Description	Syntax and Functionality	Details and Values	Via SCOM
User Brightness Control (backlight) (0x10)	Set/Write Brightness value: [S] <6E:w> 51 84 03 10 00 xx FD [P] Reply of successful request: [S] <6F:r> FD 80 BE* [P] Read Brightness value: [S] <6E:w> 51 82 01 10 AC [P] Reply of successful request: [S] <6F:r> 6E 88 02 00 10 00 00 FF 00 xx 95* [P]	10 = Command ID Where xx = 0 to 255 Min-Max Range: 0-255 (0x00-0xFF) During Read reply, these values will be present. Read/Write support.	BRT
Power Mode (Power On/Off/Sleep) (0xD6) *Note: Not the same as OSD's "Power Plan" function.	Write Power Mode: [S] <6E:w> 51 84 03 D6 00 xx 5C [P] Reply of successful request: [S] <6F:r> 5C 80 BE* [P] Read Power Mode: [S] <6E:w> 51 82 01 D6 6A [P] Reply of successful request: [S] <6F:r> 6E 88 02 00 D6 01 00 05 00 xx 67* [P]	D6 = Command ID Where xx is: 0x01 = On 0x02 = Standby 0x03 = Standby 0x04 = Standby 0x05 = OFF 0x3F = Read Command Read/Write support.	PWR
Glass Display Control™ (GDC) Brilliance Button (0xE2)	Set/Write Brilliance value: [S] <6E:w> 51 84 03 E2 00 xx 68 [P] Reply of successful request: [S] <6F:r> 68 80 BE* [P] Read Brilliance Value: [S] <6E:w> 51 82 01 E2 5E [P] Reply of successful request: [S] <6F:r> 6E 88 02 00 E2 00 00 FF 00 xx 00* [P]	E2 = Command ID Where xx = 0 to 255 Min-Max Range: 0-255 (0x00-0xFF) During Read reply, these values will be present. Read/Write support.	BRU

Description	Syntax and Functionality	Details and Values	Via SCOM
Color Mode: Kelvin Color Temperature (0x14)	Set/write Color Temperature: [S] <6E:w> 51 84 03 14 00 ww xx [P] Reply of successful request: [S] <6F:r> xx 80 BE*[P] Read Color Temperature Value: [S] <6E:w> 51 82 01 14 A8 [P] Reply of successful request: [S] <6F:r> 6E 88 02 00 14 00 00 0E 00 yy zz *[P]	14 = Command ID Where Write ww xx 05 A9 = 6500 07 AB = 8000 08 A4 = 9300 Where Read yy zz 05 AB = 6500 07 A9 = 8000 08 A6 = 9300 Read/Write support.	MCC: (Color Temperature Select)
Gamma Calibration (0x14)	Set/write Calibration: [S] <6E:w> 51 84 03 14 00 ww xx [P] Reply of successful request: [S] <6F:r> xx 80 BE*[P] Read Calibration: [S] <6E:w> 51 82 01 14 A8 [P] Reply of successful request: [S] <6F:r> 6E 88 02 00 14 00 00 0E 00 yy zz *[P]	14 = Command ID Where Write ww xx 0C A0 = VGA* 0D A1 = DVI* 0E A2 = DP 0F A3 = HDMI Where Read yy zz 0C A2 = VGA* 0D A3 = DVI* 0E A4 = DP 0F A5 = HDMI Read/Write support.	MCC: (Gamma Calibration)
Buzzer Control (0xE5) Note: May not be available on all models, please review specific datasheet if "Buzzer" is available.	write/Turn ON: [S] <6E:w> 51 84 03 E5 00 FF 5C [P] Reply of successful request: [S] <6F:r> 5C 80 BE*[P] write/Turn OFF: [S] <6E:w> 51 84 03 E5 00 00 5D [P] Reply of successful Turn OFF request: [S] <6F:r> 5D 80 BE*[P]	E5 = Command ID Where FF = Turn On Where 00 = Turn Off Write Support only.	BZZ
Touch Power Mode (0xE6)	write/Set Power Mode: [S] <6E:w> 51 84 03 E6 00 xx A1 [P] Reply of successful request: [S] <6F:r> 5C 80 BE*[P] Read Power Mode: [S] <6E:w> 51 82 01 E6 5A [P] Reply of successful request : [S] <6F:r> 6E 88 02 00 E6 01 00 FF 00 FF 53*[P]	E6 = Command ID Where xx is: 00~FF Modes are described in INB100018-6 (SCOM) document. Read/Write support.	MCC: (Touch Power Mode)
Actual Temperature (0xF0)	Read Temperature: [S] <6E:w> 51 82 01 F0 4C [P] Reply of successful request: [S] <6F:r> 6E 88 02 00 F0 01 ww xx yy zz 63*[P]	F0 = Command ID Read support. Reply 4 bytes (ww, xx, yy, zz) indicating degree in Celcius. Example: 0038	TMP
Unit Run Time (0xF3)	Read Elapsed Hours: [S] <6E:w> 51 82 01 F3 4F [P] Reply of successful request: [S] <6F:r> 6E 88 02 00 F3 01 ww xx yy zz 63*[P]	F3 = Command ID Read support. Reply in ASCII 4 bytes (ww, xx, yy, zz) indicating hours. Example: 1038	ETC

Details: Supported USB-C PD SINK

USB-C PD Sink:

- Daisy chaining via standard MST protocol:
 - Up to 4* monitors with HD resolution
- Communication and control of Display via DDC-CI or SCOM.
- USB2 in USB-C is connected via USB HUB in each monitor.
- Display unit will be tested and verified using OS with existing support for MST, Windows
- Please see list for compatible devices on page 8.
- USB-C Input supports Power Delivery (receiving), DP and USB-2.0.
- USB-C Output only supports DP and USB-2.0
- USB-C Power delivery input is set to request 20V 3A, but will only consume according to Power Consumption data (page 2)

1

* Actual max of monitors connected is platform/OS dependent

1

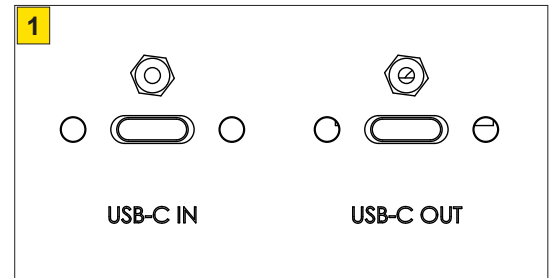
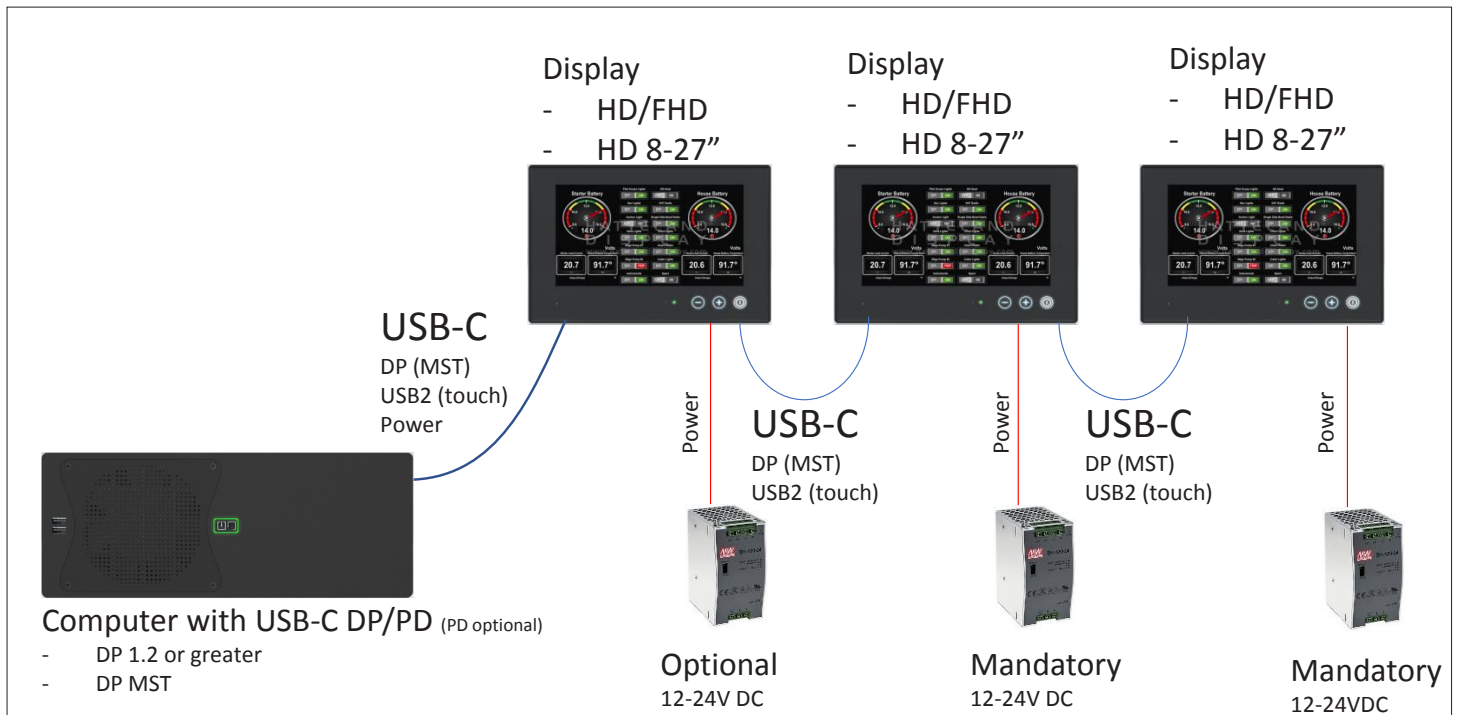

Illustration: USB-C Dasiy chaning, upto 3x FHD dispalys with touch. First display can be powered via USB-C.



List over VIC compatible video sources:

Motherboard Chipset's	Hatteland Technology Models
Q370	- HTC03-xx-AC xxxxxxxx - HTC03-xx-MP xxxxxxxx - HT20370-xx AC Yxxxxxxx - HT20370-xx DC Yxxxxxxx
Q470	- HTS31470-xx-AC xxxxxxxx - HTS41x11-xxxxx-AC xxxxxxxx
RK3399 (Arm Board)	- NanoPC-T3 : " https://www.friendlyelec.com/index.php?route=product/product&product_id=225 "

Graphics Cards	Link / Description
NVIDIA RTX4000	" https://www.pny.eu/en/professional/explore-all-products/nvidia-quadro/1047-nvidia-quadro-rtx-4000 "
Aorus Radeon™ RX 6800 XT MASTER TYPE C 16G	" https://24h.pchome.com.tw/prod/DRAD1K-A900B35OX "
GeForce RTX™ 2080 Ti TURBO 11G	" https://24h.pchome.com.tw/prod/DRAD1K-A900A64VR "
ASUS ROG Strix GeForce RTX™ 2080Ti O11G GAMING	" https://24h.pchome.com.tw/prod/DRAD1N-A900BKG3Q "
GeForce RTX 2080 SUPER GAMING OC 8G	" https://24h.pchome.com.tw/prod/DRAD1K-A900A64QK "
ASUS ROG Strix GeForce RTX™ 2080Ti O11G GAMING	" https://24h.pchome.com.tw/prod/DRAD1N-A900BKEVF "

Devices	Link / Description
Oneplus 8 (Android Phone)	" https://www.oneplus.com/no/8 "

Details: Product Packaging

P016304#04 (Main Box)

Shipping information:

Outer Dimensions: L:445.00 [17.52] x W:195.00 [7.68] x H:355.00 [13.98] mm [inch] - 0.03 cbm

Weight: TBD

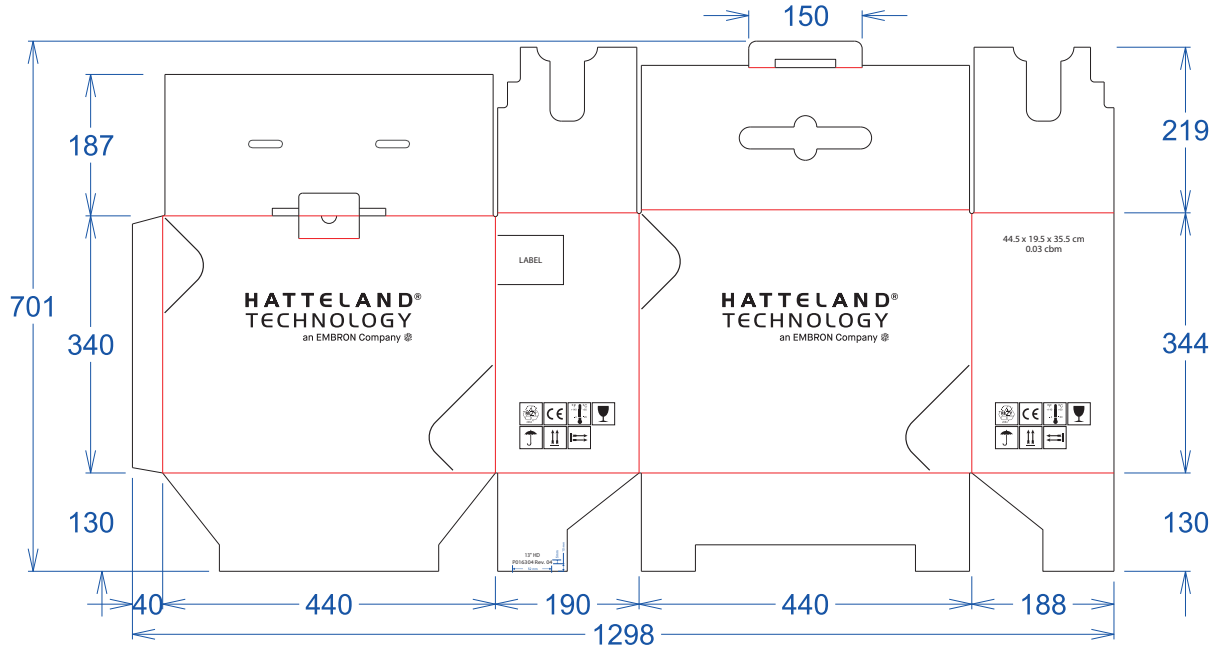

P016659#01 (Accessory Box)

Shipping information:

Outer Dimensions: 13.3" internal box 355.00 [13.97] x 75.00 [2.95] x 40.00 [1.57] (mm) [inch] (150121H04_03-02)

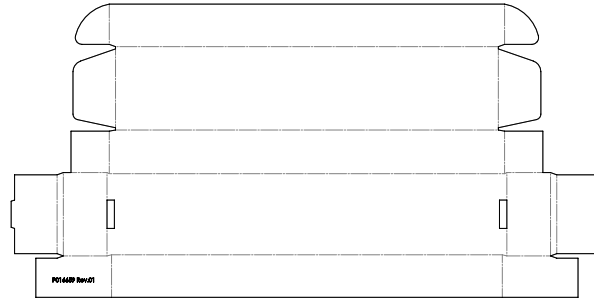

P-7076C_2 (PE Foam)

